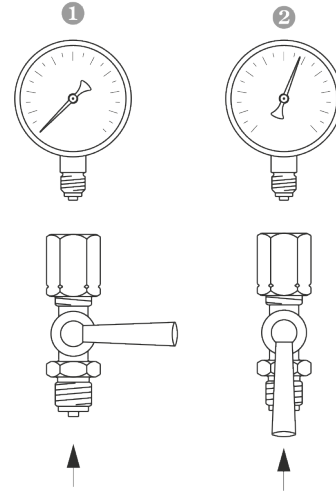
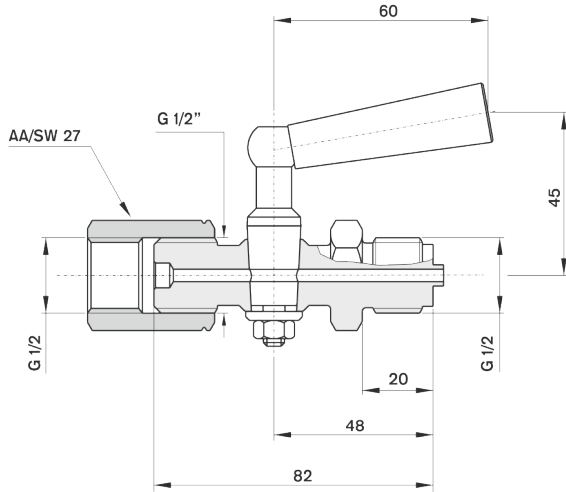

Image Schéma technique - Robinets à trois voies



1042 50 /