

Immagine di disegno tecnico - Valvola di scarico della pressione a 3 vie

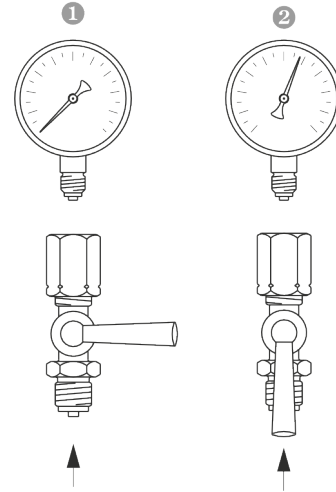
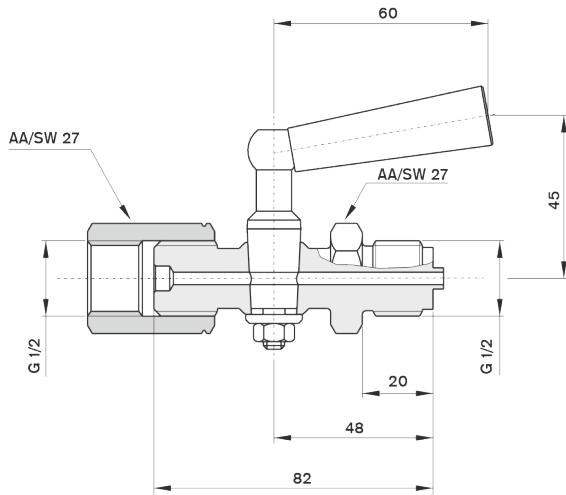

1042 25 /